

FORTISBLADES

Lames rasoir industrielles

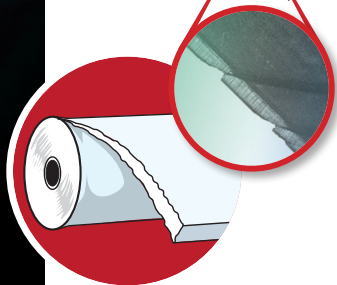

STANDARD RAZORBLADES

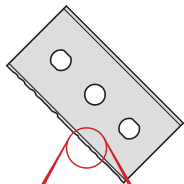

2

FORTISBLADES

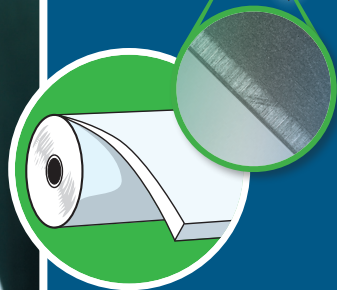
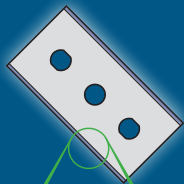

3



FORTIS



Type 80



FORTIS+



Type 82

82.055.010

















Type • Forme • Épaisseur



FORTIUS



Type TC & ZR

mm.	inch	 015	 055	 082	 856	 881
0.10	.004"					
0.15	.006"					
0.20	.008"					
0.25	.010"					
0.30	.012"					
0.40	.016"					

ÉCHELLE 1/1

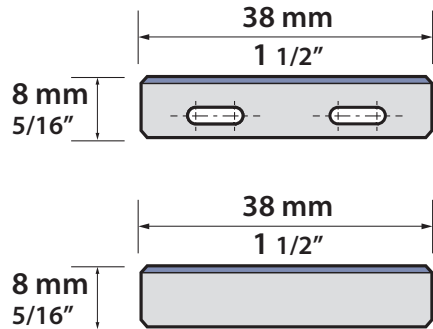

FORME 015

ÉCHELLE 1/1

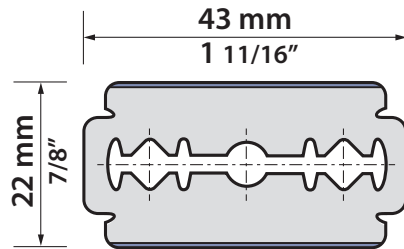

FORME 055

ÉCHELLE 1/1

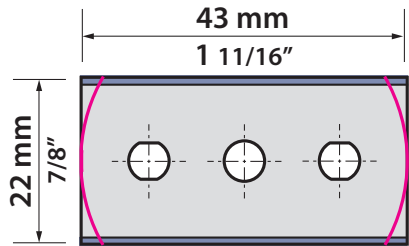

FORME 082
042

ÉCHELLE 1/1

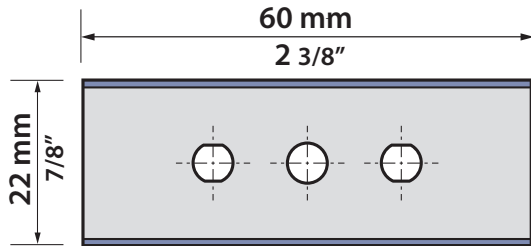

FORME 856

ÉCHELLE 1/1

FORME 881
837

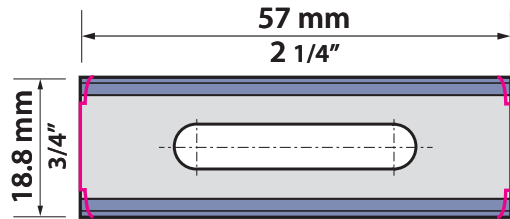

LONGUEUR DES LAMES/LONGÉVITÉ

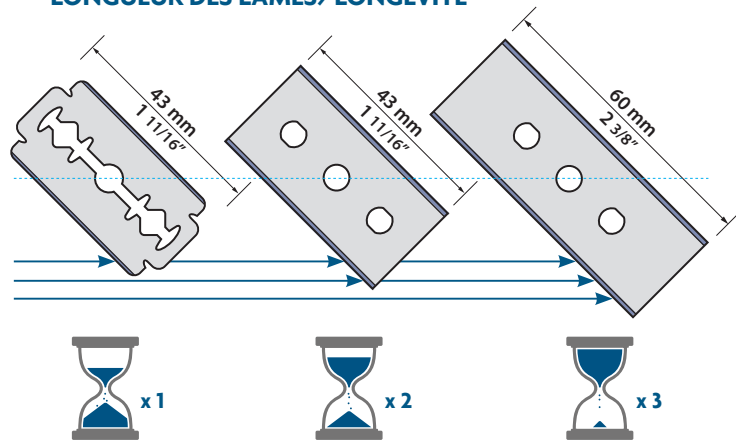

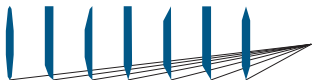

FORTISBLADES

Lames rasoir industrielles

FORTISBLADES FRANCE

135, Avenue Roger Salengro

59100 Roubaix

T 03 59 61 77 65

dominique@fortisblades.com

fortisbladesskype

WWW.FORTISBLADES.COM