

**FORTISBLADES**

Reliable performance in cutting

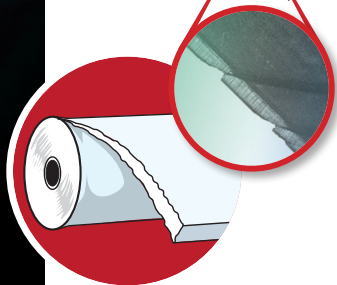

## STANDARD RAZORBLADES

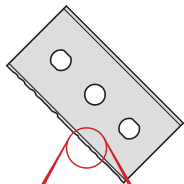

2

## FORTISBLADES

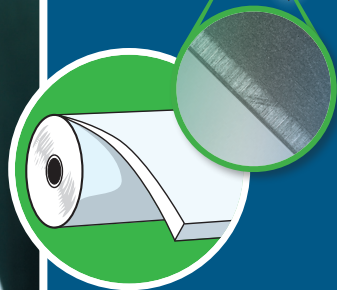
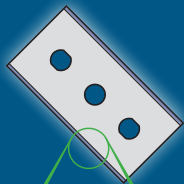

3



## FORTIS



Type 80



## FORTIS+



Type 82

82.055.010

















Type • Shape • Thickness



## FORTIUS



Type TC & ZR

mm.	inch	 015	 055	 082	 856	 881
0.10	.004"					
0.15	.006"					
0.20	.008"					
0.25	.010"					
0.30	.012"					
0.40	.016"					

SCALE 1/1

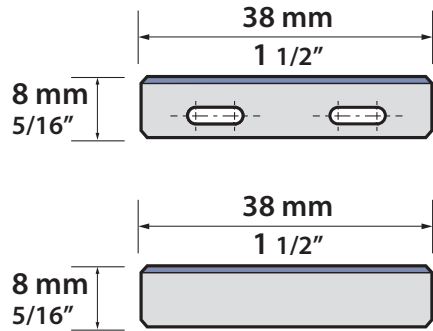

SHAPE 015

SCALE 1/1

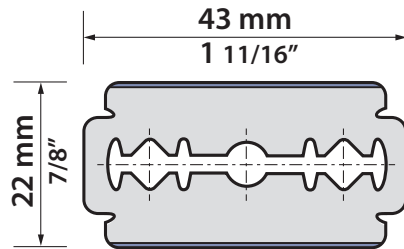

SHAPE 055

SCALE 1/1

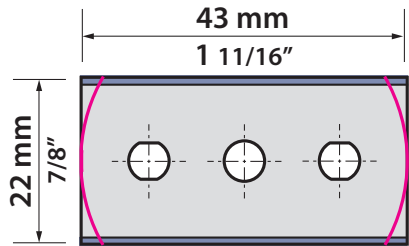

SHAPE 082  
042

SCALE 1/1

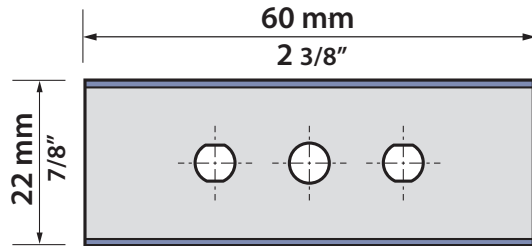

SHAPE 856

SCALE 1/1

SHAPE **881**  
**837**

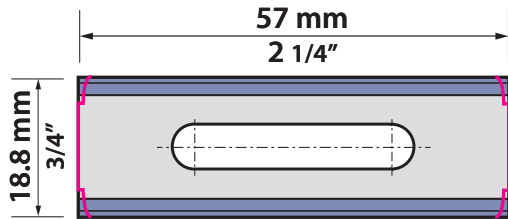

BLADES LENGTH/LIFETIME

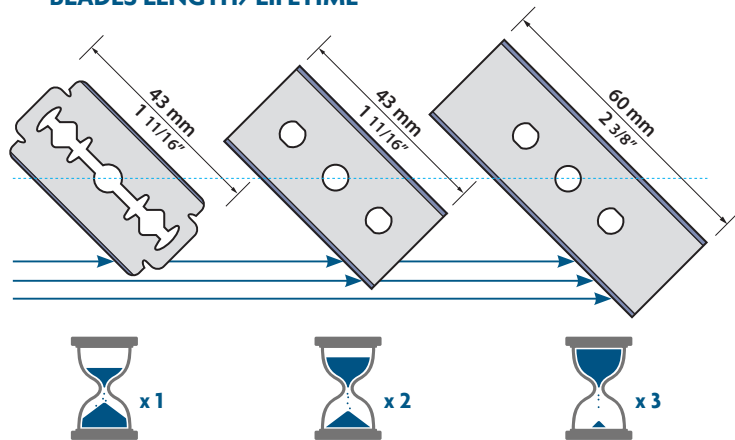

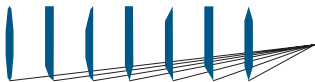

# **FORTISBLADES**

Reliable performance in cutting

## **FORTISBLADES bvba**

Esserstraat 2, Unit 8

B-8550 Zwevegem, Belgium

T +32 56 757 111

tec@fortisblades.com

fortisbladesskype

**WWW.FORTISBLADES.COM**